

3	660x81	1/1
2	660x81	1/1
1	668x660	1/1

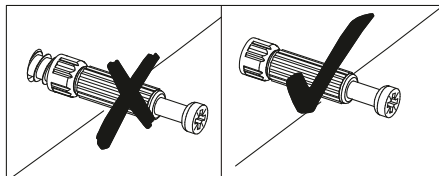

1

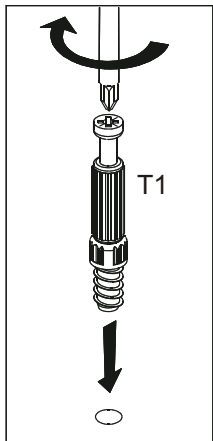
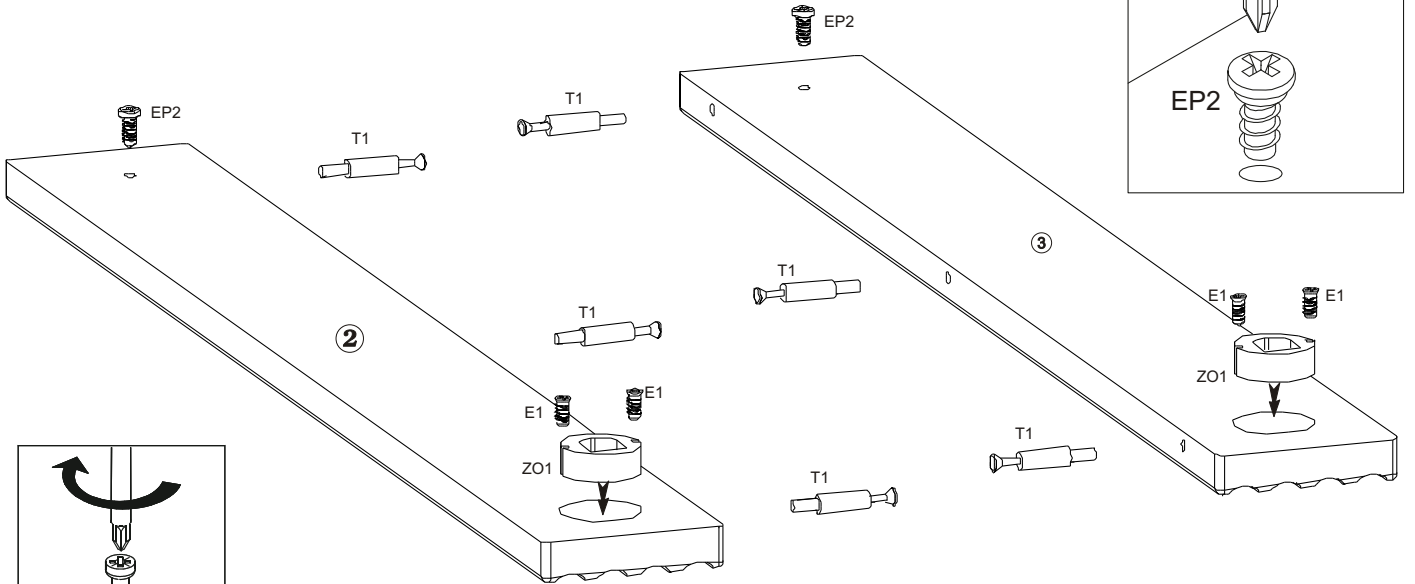
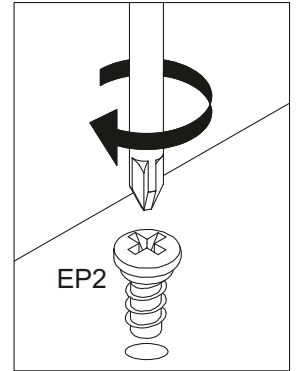
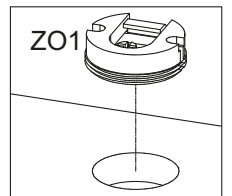
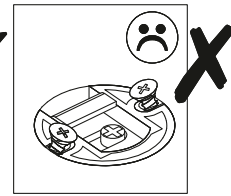
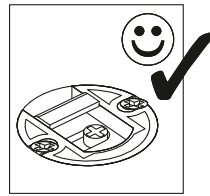
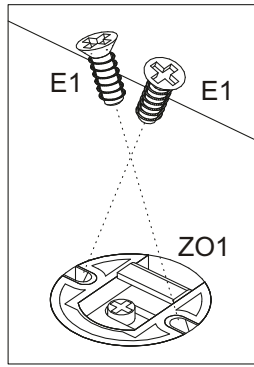
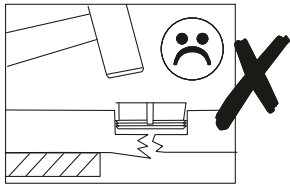
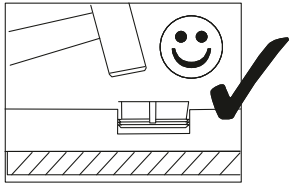

2

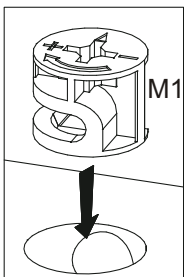
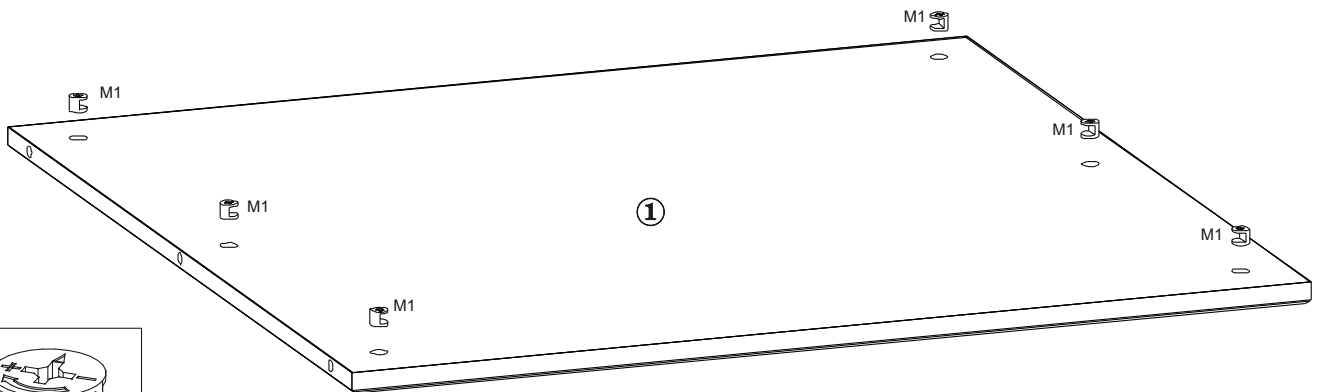

# 3 ▶

